

Capella C3 Series

Versatile, Portable 1- and 2-color Infrared Thermometers



Robust handheld IR thermometers for non-contact temperature measurement in the short-wave spectral range, especially suitable for measurements on shiny metals

- 2-color pyrometers switchable to 1-color mode
- Switchable bright green laser targeting light and through-lens view finder sighting
- Fast temperature measurements in < 1 ms
- Very high pinpoint accuracy
- Focusable optics for measuring distances up to 10 m with small spot sizes for 1.2 mm at close range with spot sizes from 0.3 mm
- Data storage for up to 32000 measured values
- 2 bright, OLED display options with measurement information and additional data
- Bluetooth and USB connectivity for easy data transmission to a PC
- Robust cast aluminum housing with shock-absorbing rubber bumpers

Model	1-color IR thermometers			2-color IR thermometers and 1-color mode	
	C309	C316	C318	C311	C322
Temperature ranges	600–1600°C 750–2500°C 900–3000°C *) 1000–3300°C *)	250–1300°C 350–1800°C 400–2500°C	180–1300°C	600–1400°C 750–1800°C 900–2500°C	300–1000°C 350–1300°C 500–1800°C
Spectral range	0.7-1.1 µm *) 0.87 µm	1.45-1.8 µm	1.65-2.1 µm	0.75-0.93 µm / 0.93-1.1 µm	1.45-1.65 µm/ 1.65-1.8 µm
Detector	Silicon	InGaAs	InGaAs	2 x Silicon	2 x InGaAs
Response time t_{90}	< 1 ms (with dynamical adaptation at low signal levels)				
Exposure time	< 0.5 ms				
Uncertainty ($\epsilon = 1, t_{90} = 1s, T_A = 23^\circ C$)	Full-scale temperatures $\leq 2500^\circ C$: 0.25% of meas. value in $^\circ C + 1K$ Full-scale temperatures $> 2500^\circ C$: 0.5% of meas. value in $^\circ C$		0.4% of measured value in $^\circ C + 1K$ (min. $2^\circ C$)	0.5% of measured value in $^\circ C + 2K$	
Repeatability ($\epsilon = 1, t_{90} = 1s, T_A = 23^\circ C$)	0.1% of measured value in $^\circ C + 1K$		0.4% of measured value in $^\circ C + 1K$ (min. $1.6^\circ C$)	0.1% of measured value in $^\circ C + 1K$	
Serial interface	USB 2.0 (to mini USB) and Bluetooth 4.0, switchable				
Display	OLED display, 160 x 128 px, temperature resolution $0.1^\circ C / ^\circ F$				
Display temperatures	Instantaneous value, minimum value, maximum value (peak picker), average value				
Device parameters	Adjustable via 4 buttons on the device: emissivity (0.050–1.200), emissivity slope (only C311 / C322: 0.650–1.450), transmittance (5-100%), Hi and Lo alarm limit, selection of measuring locations, storage modes (only display without storage), 1 value automatically, 1 value with key confirmation, continuously (1 ms), interval (with adjustable measuring and pause times), language (English + German), temperature unit ($^\circ C / ^\circ F$). Adjustable via serial interface: specify measuring locations (100), response time (<1 ms–10s).				
Power supply	Rechargeable Li-Ion battery, 3.7 V, 2600 mAh, changeable. With protection circuit. Charge via USB port. Battery life > 8 h				
Data storage	Up to 32000 measured values including date, time, measuring parameters, measuring location designation				
Sightings (switchable)	<ul style="list-style-type: none"> ■ Laser targeting light (green, $\lambda=515$ nm, $P < 1$ mW, laser class II according to IEC 60825-1) ■ Parallax-free through-lens view finder with aiming mark and temperature display, with adjustable brightness attenuation for high measuring temperatures (polarizer in the eyepiece) 				
Mounting thread	Tripod thread 1/4 "UNC				
Ambient temperature	0–60°C				
Relative humidity	No condensing conditions				
Housing/protect. class	Aluminum, IP65 to DIN 40 050, handle: plastic				
Weight	Approx. 1200 g (2.6 lb)				
CE label	According to EU directives for electromagnetic immunity				

Optics with Easy Focus Adjustment and High Optical Resolution

At the focal point of the lens (focal distance) the spot size diameter is smallest. Measurements made outside of the focus distance are also possible (in a shorter or longer distance than the focus distance) to determine the average temperature of a bigger spot.

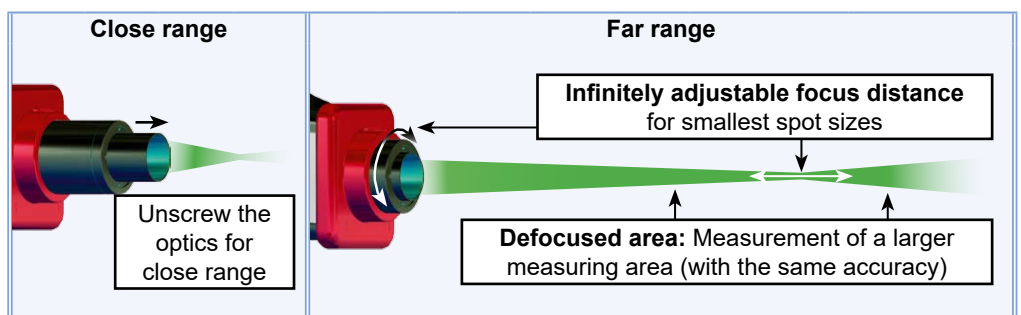

Table values are exemplary, intermediate values must be interpolated

Model	Temp. ranges	Spot size Ø M [mm]	Measuring / focus distance a [mm] (adjustable)											
			116	130	150	170	380	500	700	1000	2000	3000	4000	5000
C309	all	0.3	0.4	0.5	0.6	1.2	1.5	2	2.8	5.8	7.8	11	14	29
C316	all													
C318	FSC $\geq 1200^\circ C$	0.5	0.7	0.8	1	1.7	2.7	3.7	5.6	10	14	19	24	51
C311 / C322	FSC $\geq 1300^\circ C$													
C318	100–700°C													
C322	300–1000°C													

FSC = Full-scale temperatures

Aperture Ø: FSC $\leq 1400^\circ C$: 15 mm; FSC $> 1400^\circ C$: 8 mm

Expanding Possibilities

The new Capella C3 Series of hand-held, battery operated 1- and 2-color IR thermometers brings all the advanced measurement capabilities of PSC fixed mount pyrometers to the workplace in portable form. The comprehensive model range of the series includes short-wave devices for precise measurement of metals, welding, molten glass, semi-conductors and ceramics. Measurement of molten metals and pouring streams is simplified with C311 models.

For applications requiring simultaneous measurements in two spectral ranges, 2-color models determine temperature by forming a radiation ratio (quotient). This method negates the need to know the emissivity of the target material or fill the sensor's spot size completely with the target being measured. While the use of 2-color devices for measurement of stationary objects or processes has become an industry standard, the advantages of 2-color are unique in Capella C3 hand-held devices.

Innovative Features

Informative display:

- Clear OLED color display with all measurement information
- Temperature display in view finder
- Select additional displays: active limit value outputs, maximum, minimum or average values

Simple device operation:

- All settings directly on the device
- Quick switchover between single / continuous measurement

Convenient connections to the PC software:

- USB for charging and data readout
- Bluetooth for wireless data transmission

Unique model designs:

- 2-color pyrometers (2-color + 1-color devices)
- Radiation pyrometers (1-color devices)

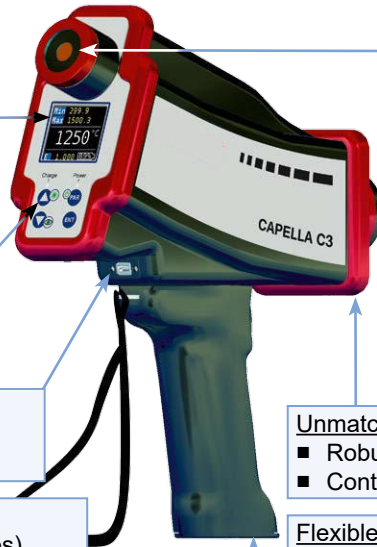

Dual sighting device:

- View finder with eye protection filter
- Bright green laser targeting light for spot size marking even on hot glowing objects

Fast object focusing:

- Easy focusing to measuring distance with the smallest focus
- Optics extendable for close range

Unmatched toughness:

- Robust aluminum housing with rubber bumper
- Continuous ambient temperature compensation

Flexible usage:

- Photo tripod thread for stationary measurements

Versatile Sighting Methods

Precision measurement of objects is assured with the two switchable sighting methods using the Capella C3 Series. Choose from bright green laser targeting or parallax-free through-lens view finder with adjustable brightness, aiming reticule and integrated temperature displays.

The vivid green laser is highly visible on hot (red) glowing targets and defines the center of the spot size. An adjustable polarizing filter darkens and protects the eye when viewing extremely bright targets.

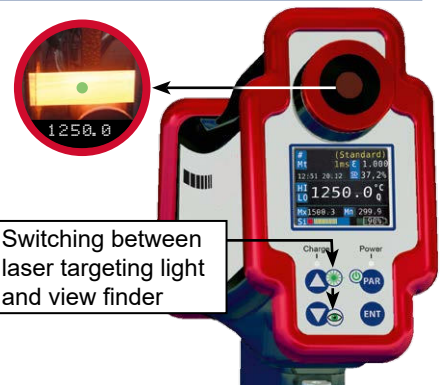

Intuitive Options for Measurement, Display and Evaluation

The quick menu and the menu:

- Measurement parameters can be changed directly in the main display.
- All measurement and device settings can be found in the menu. Operation is via 4 adjustment buttons.

Two display formats:

- Large display for quick measurement information.
- Detailed display for additional parameter measurement information

Some special features:

- Define measuring locations: Measuring location designations can be assigned under which the measuring parameters and operating mode can be predefined. These can be easily selected on the device to store all measured values including date and time. Data can easily be sorted for quick retrieval.
- At the same time or optionally, display current value, maximum, minimum average temperature
- Several operating modes: The measurement button can be adapted to the requirements:
 - Display mode: No storage, display only.
 - Auto save: Press trigger button and save a value automatically.
 - Continuous measurement: Measurement with storage as fast as possible (1 ms a measured value).
 - Interval mode: Measurement with definable measuring and pause times.
- Alarm display for measurement temperature overflow or underflow.
- Signal strength bar: Assures that there is enough signal for safe data logging.

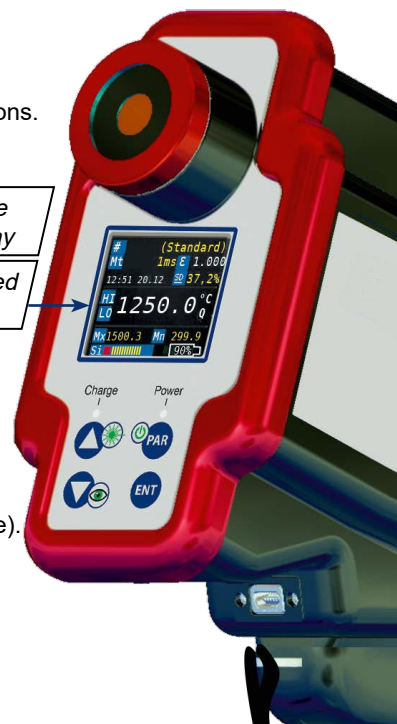
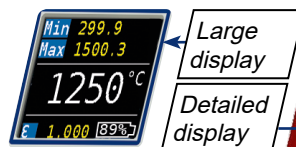

Powerful and Intuitive *SensorTools* Software

Intuitive *SensorTools* PC software:

- Current measured value display
- Graphical evaluation of read out measurement data including time stamp and measurement parameters
- Pyrometer parameters adjustment
- Adjustment of additional pyrometer settings, not available on the device
- Manage measuring locations and material lists: Define measuring location designations or material lists with preset measuring parameters and storage mode
- Export measured values filtered into csv files
- Transfer pyrometer settings to other devices
- Save and print settings
- Create service and parameter files to display all device and software settings

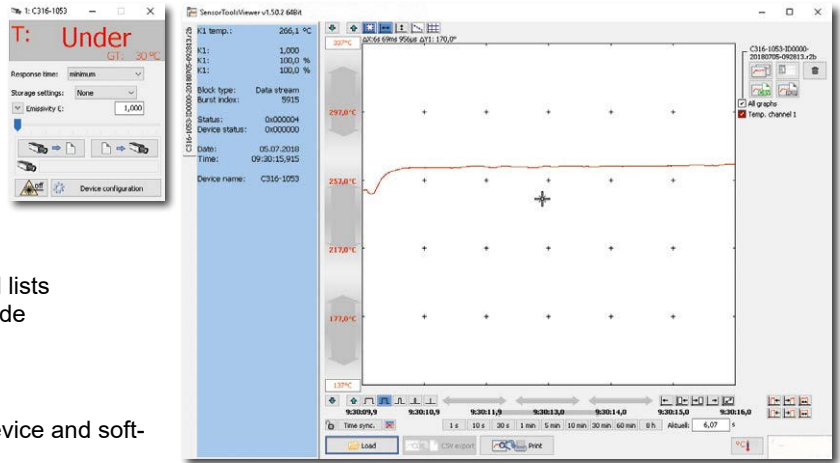

Dimensions

Dimensions in mm

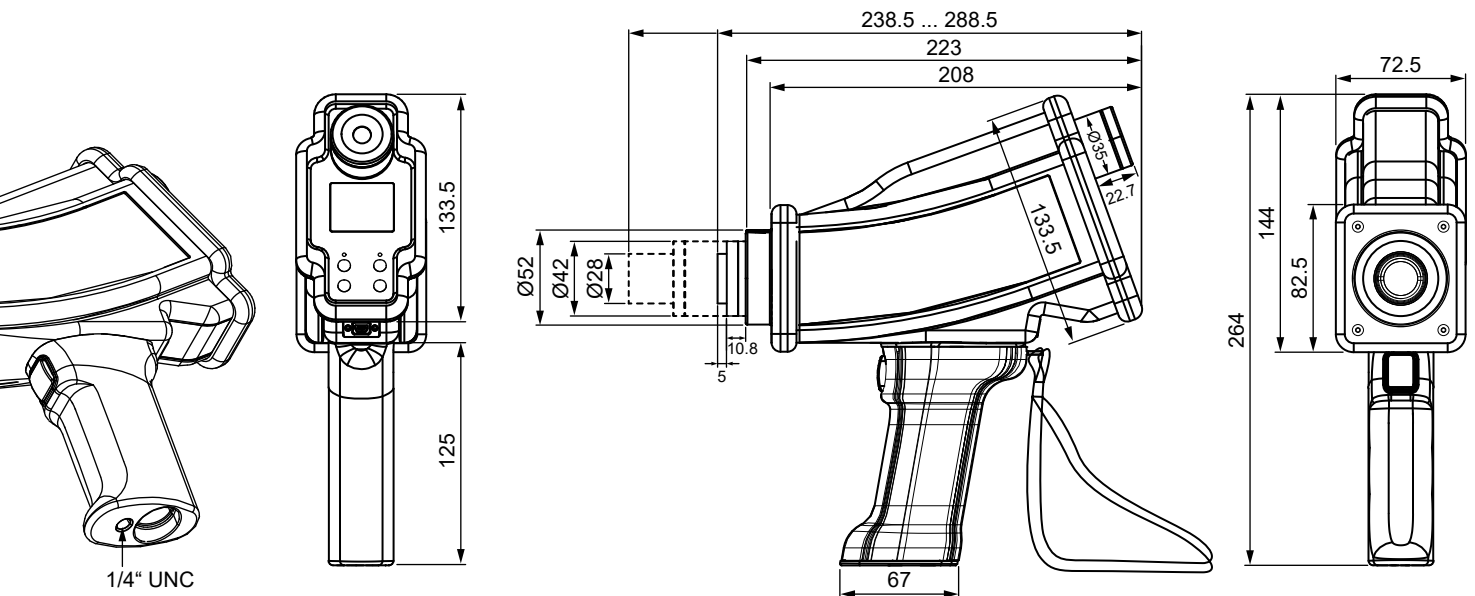

Reference Information

Specify model with required temperature range.

Scope of delivery:

Device with rechargeable Li-ion battery, wrist strap, USB cable, USB charger (power adapter), protective carrying case, calibration certificate ISO9001, user manual, *SensorTools* software.

Accessories:

Rechargeable Li-ion replacement battery

(Sept. 18, 2018)

PROCESS SENSORS CORPORATION

IR Temperature Sales: 787 Susquehanna Avenue, Franklin Lakes, NJ USA

Tel: 201-485-8773 • Fax: 201-485-8770

Corporate Headquarters: 113 Cedar Street, Milford, MA USA • Tel: 508-473-9901 • Fax: 508-473-0715

www.ProcessSensors.com • irtemp@processsensors.com

A KPM Analytics Company